

 **POMPE CENTRIFUGHE MONOGIRANTI AD ASSE NUDO**

 *Single stage bare shaft centrifugal pumps*

 *Pompes centrifuge arbre-nu monoturbine*

 *Bombas centrifugas - un rodete - eje libre*

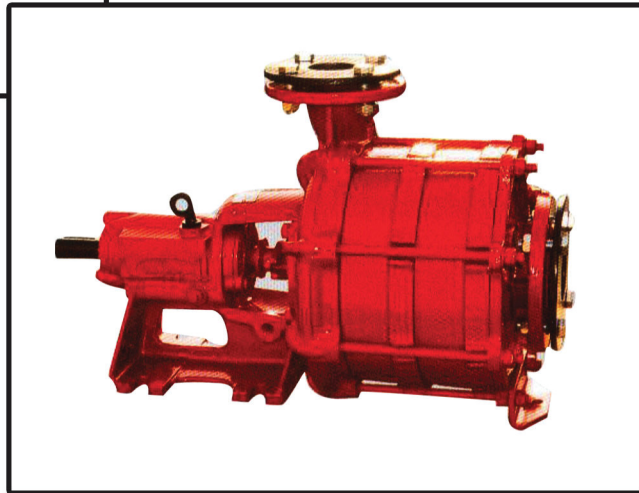
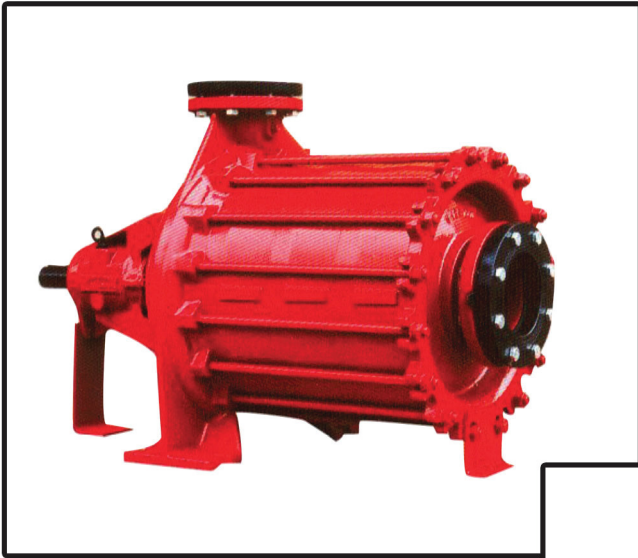

Serie **JCS-P** per liquidi non corrosivi
 Series **JCS-P** for not corrosive liquids
 pour liquides ras corrosifs
 para líquidos no corrosivos

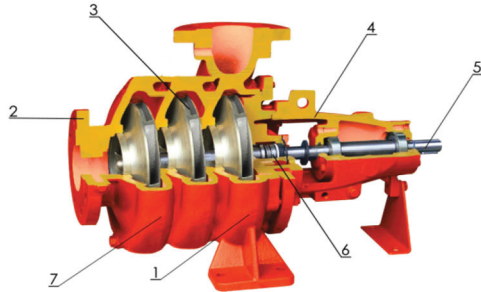

- 1 **CORPO POMPA - PUMP CASING**
Ghisa grigia a grana fine - Grey fine grained cast iron
- 2 **COPERCHIO ASPIRAZIONE - SUCTION COVER**
Ghisa grigia a grana fine - Grey fine grained cast iron
- 3 **GIRANTE - IMPELLER**
Ghisa grigia a grana fine - Grey fine grained cast iron
- 4 **SUPPORTO - SUPPORT**
Ghisa grigia a grana fine - Grey fine grained cast iron
- 5 **ALBERO - SHAFT**
Acciaio 38NCD4 - Steel 38NCD4
- 6 **TENUTA MECCANICA - MECHANICAL SEAL**
- 7 **DIFFUSORE - DIFFUSER**
Ghisa grigia a grana fine - Grey fine grained cast iron

Serie **JCS-P/BRX** per liquidi leggermente corrosivi
 Series **JCS-P/BRX** for lightly corrosive liquids

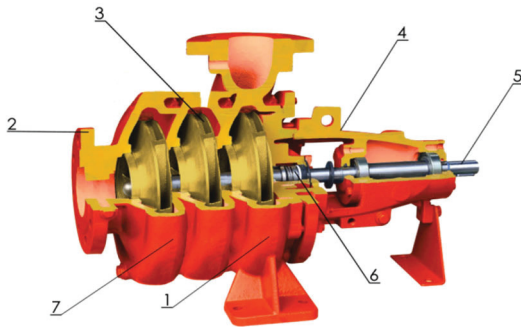

- 1 **CORPO POMPA - PUMP CASING**
Ghisa grigia a grana fine - Grey fine grained cast iron
- 2 **COPERCHIO ASPIRAZIONE - SUCTION COVER**
Ghisa grigia a grana fine - Grey fine grained cast iron
- 3 **GIRANTE - IMPELLER**
Bronzo - Bronze
- 4 **SUPPORTO - SUPPORT**
Ghisa grigia a grana fine - Grey fine grained cast iron
- 5 **ALBERO - SHAFT**
Acciaio inox Aisi 304 - Stainless Steel Aisi 304
- 6 **TENUTA MECCANICA - MECHANICAL SEAL**
- 7 **DIFFUSORE - DIFFUSER**
Ghisa grigia a grana fine - Grey fine grained cast iron

Serie **JCS-P/TBX** per liquidi non corrosivi
 Series **JCS-P/TBX** for not corrosive liquids

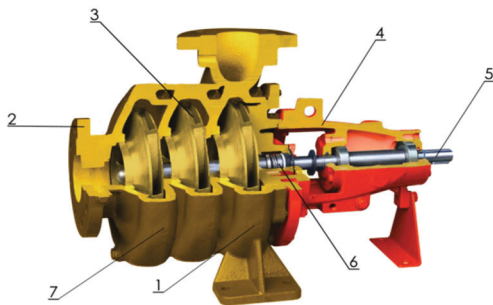

- 1 **CORPO POMPA - PUMP CASING**
Bronzo - Bronze
- 2 **COPERCHIO ASPIRAZIONE - SUCTION COVER**
Bronzo - Bronze
- 3 **GIRANTE - IMPELLER**
Bronzo - Bronze
- 4 **SUPPORTO - SUPPORT**
Ghisa grigia a grana fine - Grey fine grained cast iron
- 5 **ALBERO - SHAFT**
Acciaio inox Aisi 304 - Stainless Steel Aisi 304
- 6 **TENUTA MECCANICA - MECHANICAL SEAL**
- 7 **DIFFUSORE - DIFFUSER**
Bronzo - Bronze



Pompe autoadescanti per acque sporche ad asse nudo
Self - priming bare shaft pumps for dirty waters
 Pompes auto-amorçante arbre nu pour eaur chargées
 Bombas autocebantes eje libre para agua sucia

Serie **CS-P**
 Series

Tipo Type	CS-P352S	Tipo Type	CS-P352BRX	Tipo Type	CS-P352TBX
-----------	-----------------	-----------	-------------------	-----------	-------------------

Girante - Impeller: ø 152 mm
 Apertura - Opening: 6 mm

Bocche pompa Ports pump	Giri pompa/1'	m3/h	12	15	18	21	24	27	30	33	36						
												G/min	53	67	80	93	107
DNa	DNm	RPM	l/1'	200	250	300	350	400	450	500	550	600					
65 mm	50 mm	1450	H mt.	13	12	11	8.5	7									
			H feet	43	40	37	28	23									
			Hp ass.	0.7	0.75	0.8	0.92	0.95									
		2200	H mt.	32.4	31.3	30	29	27	25	21.5	18.9	16					
			H feet	108	104	100	97	90	83	72	63	53					
			Hp ass.	1.8	2	2.2	2.4	2.6	2.8	3	3.2	3.3					
2400	H mt.	38.4	37	36	34.5	32	29.4	25.6	22.4	19.2							
	H feet	128	123	120	115	107	98	85	75	64							
	Hp ass.	2.4	2.6	2.8	3.1	3.4	3.6	3.9	4.1	4.2							
2600	H mt.	45	43.5	42	40	37.5	34.5	30	26.2	22.5							
	H feet	150	145	140	133	125	115	100	87	75							
	Hp ass.	3	3.3	3.6	3.9	4.3	4.5	4.9	5.2	5.3							
2900	H mt.	54	52	50	48	45	41	36	31	27							
	H feet	180	173	167	160	150	137	120	103	90							
	Hp ass.	3.9	4.3	4.6	5	5.5	5.6	6.4	6.6	6.8							
3000	H mt.	60	58	56	54	50	46	40	35	30							
	H feet	200	193	187	180	167	153	133	117	100							
	Hp ass.	4.6	5.1	5.5	6	6.6	7	7.6	8	8.2							

Tipo Type	CS-P353S	Tipo Type	CS-P353BRX	Tipo Type	CS-P353TBX
-----------	-----------------	-----------	-------------------	-----------	-------------------

Girante - Impeller: ø 152 mm
 Apertura - Opening: 6 mm

Bocche pompa Ports pump	Giri pompa/1'	m3/h	12	15	18	21	24	27	30	33	36						
												G/min	53	67	80	93	107
DNa	DNm	RPM	l/1'	200	250	300	350	400	450	500	550	600					
65 mm	50 mm	1450	H mt.	18.6	16.4	14	11.3	10.4									
			H feet	62	55	47	38	35									
			Hp ass.	0.75	0.81	0.86	1.02	1.05									
		2200	H mt.	49	48	43	40	36.5	32.3	28	26	24					
			H feet	163	160	143	133	122	108	93	87	80					
			Hp ass.	2.2	2.4	2.6	2.7	2.8	3	3.2	3.6	3.7					
2400	H mt.	58.8	58.2	51.8	49	43.5	38.4	31	30.7	28.8							
	H feet	196	194	173	163	145	128	103	102	96							
	Hp ass.	2.8	3.1	3.3	3.5	3.6	3.9	4.1	4.4	4.7							
2600	H mt.	69	68.4	60.9	57	51	45	39	36	33.8							
	H feet	230	228	203	190	170	150	130	120	113							
	Hp ass.	3.6	3.9	4.2	4.4	4.6	4.9	5.2	5.5	6							
2900	H mt.	81	79	72	70	61	53.5	46	45	40							
	H feet	270	263	240	233	203	178	153	150	133							
	Hp ass.	4.7	5	5.5	5.7	6	6.5	6.7	6.9	7.2							
3000	H mt.	92	91	81	76	68	60	52	48	45							
	H feet	307	303	270	253	227	200	173	160	150							
	Hp ass.	5.5	6	6.5	6.8	7	7.5	8	8.5	9.2							



Pompe autoadescanti per acque sporche ad asse nudo
Self - priming bare shaft pumps for dirty waters
 Pompes auto-amorçante arbre nu pour eaur chargées
 Bombas autocebantes eje libre para aqua sucia

Serie **CS-P**
 Series

Tipo Type **CS-P65225ERS**

Bocche pompa Ports pump		Giri pompa/1'	m3/h	6	12	18	21	24	27	30	33	36	39								
DNa	DNm			RPM	G/min	27	53	80	93	107	120	134	147	160	174						
			l/1'	100	200	300	350	400	450	500	550	600	650								
65 mm	50 mm	2000	H mt.	81	75	64	56	47	37	25											
			H feet	270	250	213	187	157	123	83											
			Hp ass.	4.5	5.7	6.5	6.7	7	7	7											
		2200	H mt.	101	94	82	74	64	54	42											
			H feet	337	313	273	247	213	180	140											
			Hp ass.	5.7	7.3	8.5	9	9	9.2	9.2											
		2600	H mt.	136	132	123	114	105	94	83	70	57									
			H feet	453	440	410	380	350	313	277	233	190									
			Hp ass.	9	11.3	13	14	14.5	15	15	15	15									
		2900	H mt.	170	167	158	151	140	130	118	105	89	70								
			H feet	567	557	527	503	467	433	393	350	297	233								
			Hp ass.	11.7	15	17.5	19	19	20	21	21	21	21								

Tipo Type **CS-PS554AS** Tipo Type **CS-PS554ABRX**

Bocche pompa Ports pump		Giri pompa/1'	m3/h	18	21	24	27	30	33	36	39	42	48	54	60	66						
DNa	DNm			RPM	G/min	80	93	107	120	134	147	160	174	187	214	240	267	294				
			l/1'	300	350	400	450	500	550	600	650	700	800	900	1000	1100						
65 mm	50 mm	2900	H mt.	281	276	272	264	252	245	238	229	222	191	173	168	150						
			H feet	937	920	907	880	840	817	793	763	740	637	577	560	500						
			Hp ass.	44	48	52	56	59	61	65	72	73	79	86	88	95						

Tipo Type **CS-P552AS** Tipo Type **CS-P552ABRX** Tipo Type **CS-P552ATBX**

Girante Prim. - Prim. Impeller: ø 260 mm

Girante Sec. - Sec. Impeller: ø 205 mm

Apertura - Opening: 6 mm

Apertura - Opening: 6 mm

Bocche pompa Ports pump		Giri pompa/1'	m3/h	12	15	18	21	24	27	30	33	36	39	42	48	54	60	66						
DNa	DNm			RPM	G/min	53	67	80	93	107	120	134	147	160	174	187	214	240	267	294				
			l/1'	200	250	300	350	400	450	500	550	600	650	700	800	900	1000	1100						
65 mm	50 mm	1450	H mt.	40	39.5	38.5	37	35.5	33.5	31	28	24.5	20.5											
			H feet	133	132	128	123	118	112	103	93	82	68											
			Hp ass.	2.7	3	3.5	3.7	4	4.3	4.6	4.9	5.2	5.5											
		1750	H mt.	57	56	55	53	51.5	49.5	47	44	40.5	37											
			H feet	190	187	183	177	172	165	157	147	135	123											
			Hp ass.	5	5.5	6	6.5	7.5	7.8	8.5	8.9	9.3	9.7											
		2000	H mt.	73	73	72	70	69	67	64	61	58	55	46										
			H feet	243	243	240	233	230	223	213	203	193	183	153										
			Hp ass.	7.5	8.5	9	10	10.5	11.5	12	12.5	13	13.5	14										
		2200	H mt.	89	88	87	86	84	81	79	77	74	72	64	52									
			H feet	297	293	290	287	280	270	263	257	247	240	213	173									
			Hp ass.	9.5	10.5	11.5	12.5	13.5	14.5	15	16	16.9	17.5	18.5	19.5									
		2400	H mt.			104	104	103	102	101	98	96	93	90	82	73								
			H feet			347	347	343	340	337	327	320	310	300	273	243								
			Hp ass.			14	16	16	17	18	19	20	20.5	21	23	24								
		2600	H mt.			124	123	122	121	120	118	115	112	109	100	91	90							
			H feet			413	410	407	403	400	393	383	373	363	333	303	300							
			Hp ass.			16	18	19	20	21	22	23	24	25	26.5	28	29							
		2900	H mt.					148	147	144	144	140	137	135	127	117	106	93						
			H feet					493	490	480	480	467	457	450	423	390	353	310						
			Hp ass.					24	25.5	28	27	29	30	31	33	35	36.5	38						



Pompe autoadescanti per acque sporche ad asse nudo
Self - priming bare shaft pumps for dirty waters
 Pompes auto-amorçante arbre nu pour eau chargées
 Bombas autocebantes eje libre para agua sucia

Serie **CS-P**
 Series

Tipo Type CS-P65212S				Tipo Type CS-P65212BRX				Tipo Type CS-P65212TBX							
Girante Prim. - Prim. Impeller: ø 205 mm								Girante Sec. - Sec. Impeller: ø 205 mm							
Apertura - Opening: 9 mm								Apertura - Opening: 12 mm							

Bocche pompa Ports pump	Giri pompa/1'	m3/h	26	29	34	40	46	52	60	69	77	83	89					
														G/min	115	128	152	179
DNa	DNm	RPM	l/1'	430	480	570	670	760	860	1000	1150	1290	1380	1480				
80 mm	65 mm	1450	H mt. 28 H feet 93 Hp ass. 4.4	24.5 73	22 67	20 67	16 53	13 43	7 23									
		1750	H mt. 38 H feet 127 Hp ass. 6.9	37 117	35 117	33.5 112	30 100	27 90	21 70									
		2000	H mt. 49 H feet Hp ass.	47 163	45.4 157	43 143	40 133	34.5 115	28 93									
		2200	H mt. 60 H feet Hp ass.	59 200	57 197	54.5 190	51 182	45 150	39 130									
		2400	H mt. 71 H feet Hp ass.	69 237	69 230	68 227	64 213	58 193	52 173	48 160								
		2600	H mt. 83 H feet Hp ass.	80 277	77 267	73 257	70 243	66 220	59 197	54 180								
		2900	H mt. 102 H feet Hp ass.	100 340	95 333	90 317	82 300	76 273	69 253	230 230								

Tipo Type CS-P652A2S				Tipo Type CS-P652A2BRX				Tipo Type CS-P652A2TBX							
Girante Prim. - Prim. Impeller: ø 260 mm								Girante Sec. - Sec. Impeller: ø 205 mm							
Apertura - Opening: 9 mm								Apertura - Opening: 12 mm							

Bocche pompa Ports pump	Giri pompa/1'	m3/h	27	30	36	42	48	54	63	72	81	87	93					
														G/min	120	134	160	187
DNa	DNm	RPM	l/1'	450	500	600	700	800	900	1050	1200	1350	1450	1550				
80 mm	65 mm	1450	H mt. 35 H feet 117 Hp ass. 6.5	34 113	33 110	31 103	28 93	24 80	19 63									
		1750	H mt. 52.3 H feet 174 Hp ass. 10.5	52 173	51 170	49 163	47 157	44 147	39 130									
		2000	H mt. 69 H feet Hp ass.	67 230	66 223	64 220	61 213	56 203	50 187									
		2200	H mt. 84 H feet Hp ass.	83 280	82 277	80 273	77 267	72 257	67 240									
		2400	H mt. 99 H feet Hp ass.	98 330	96 327	95 320	90 317	84 300	78 280									
		2600	H mt. 116 H feet Hp ass.	114 387	112 380	108 373	103 360	96 343	92 320									
		2900	H mt. 144 H feet Hp ass.	143 480	140 477	135 467	128 450	124 427	118 413									

Tipo Type CS-P653A2S				Tipo Type CS-P653A2BRX				Tipo Type CS-P653A2TBX							
Girante Prim. - Prim. Impeller: ø 260 mm								Girante Sec. - Sec. Impeller: ø 205 mm							
Apertura - Opening: 9 mm								Apertura - Opening: 12 mm							

Bocche pompa Ports pump	Giri pompa/1'	m3/h	27	30	36	42	48	54	63	72	81	87	93					
														G/min	120	134	160	187
DNa	DNm	RPM	l/1'	450	500	600	700	800	900	1050	1200	1350	1450	1550				
80 mm	65 mm	1450	H mt. 50 H feet 167 Hp ass. 9.5	49 163	47 157	44 147	40 133	36 120	27 90									
		1750	H mt. 74 H feet Hp ass.	73 247	72 243	70 233	66 220	62 207	56 187									
		2000	H mt. 96 H feet Hp ass.	95 320	92 317	91 307	86 303	81 287	72 270									
		2200	H mt. 117 H feet Hp ass.	116 390	115 387	111 383	110 370	104 367	96 347									
		2400	H mt. 139 H feet Hp ass.	138 463	133 460	128 443	120 427	110 400	96 367									
		2600	H mt. 163 H feet Hp ass.	161 543	159 537	153 530	146 510	135 487	130 450									
		2900	H mt. 202 H feet Hp ass.	200 673	197 667	190 657	181 633	167 603	153 557									



Pompe autoadescanti per acque sporche ad asse nudo
Self-priming bare shaft pumps for dirty waters
 Pompes auto-amorçante arbre nu pour eau chargées
 Bombas autocebantes eje libre para agua sucia

Serie **CS-P**
 Series

Tipo Type CS-P1002BS					Tipo Type CS-P1002BBRX					Tipo Type CS-P1002BTBX				
-----------------------------	--	--	--	--	-------------------------------	--	--	--	--	-------------------------------	--	--	--	--

Girante Prim. - Prim. Impeller: ø 400 mm
 40.05340454

Girante Sec. - Sec. Impeller: ø 330 mm
 Apertura - Opening: 15 mm

Bocche pompa Ports pump	Giri pompa/1'	m3/h																
			72	84	96	108	120	135	150	165	180	195	210	225	240	270		
DNa	DNm	RPM	G/min															
			320	374	427	481	534	601	668	734	801	868	935	1,001	1,068	1,202		
			I/1'															
			1200	1400	1600	1800	2000	2250	2500	2750	3000	3250	3500	3750	4000	4500		
125 mm	100 mm	1450	H mt.	89	88	87	86	84	82	81	78	75	72	70				
			H feet	297	293	290	287	280	273	270	260	250	240	233				
			Hp ass.	37.5	45	49.5	53.5	57	60	65	67	70	74	76				
		1750	H mt.	128	127	125	122	120	117	115	112	109	104	103				
			H feet			427	423	417	407	400	390	383	373	363	347	343		
			Hp ass.			75	80	88	93	95	104	111	116	122	125	130		
2000	H mt.	166	165	163	162	160	157	152	150	145	143	140	129					
	H feet			553	550	543	540	533	523	507	500	483	477	467	430			
	Hp ass.	109	114	120	130	134	143	152	160	165	174	181	190					

Tipo Type CS-P1002CS					Tipo Type CS-P1002CBRX					Tipo Type CS-P1002CTBX				
-----------------------------	--	--	--	--	-------------------------------	--	--	--	--	-------------------------------	--	--	--	--

Girante Prim. - Prim. Impeller: ø 380 mm
 Apertura - Opening: 14 mm

Girante Sec. - Sec. Impeller: ø 330 mm
 Apertura - Opening: 15 mm

Bocche pompa Ports pump	Giri pompa/1'	m3/h																
			72	84	96	108	120	135	150	165	180	195	210	225	240	270		
DNa	DNm	RPM	G/min															
			320	374	427	481	534	601	668	734	801	868	935	1,001	1,068	1,202		
			I/1'															
			1200	1400	1600	1800	2000	2250	2500	2750	3000	3250	3500	3750	4000	4500		
300 mm	250 mm	1450	H mt.	85	84	82	81	80	78	77	74	71	68	66				
			H feet	283	280	273	270	267	260	257	247	237	227	220				
			Hp ass.	40.5	43	47	50	54	57	61.5	63	66	69.5	71				
		1750	H mt.	116	115	113	110	108	106	104	101	98	94	93				
			H feet			387	383	377	367	360	353	347	337	327	313	310		
			Hp ass.			68	73	79	84	89	94	100	105	110	112	117		
2000	H mt.	150	149	147	146	145	142	138	136	131	129	126	116					
	H feet			500	497	490	487	483	473	460	453	437	430	420	387			
	Hp ass.	98	103	108	117	121.5	130	138	145	149	156	163	170					

Tipo Type CS-P1003AS					Tipo Type CS-P1003ABRX					Tipo Type CS-P1003ATBX				
-----------------------------	--	--	--	--	-------------------------------	--	--	--	--	-------------------------------	--	--	--	--

Girante Prim. - Prim. Impeller: ø 419 mm
 Apertura - Opening: 14 mm

Girante Sec. - Sec. Impeller: ø 330 mm
 Apertura - Opening: 15 mm

Bocche pompa Ports pump	Giri pompa/1'	m3/h																
			72	84	96	108	120	135	150	165	180	195	210	225	240			
DNa	DNm	RPM	G/min															
			320	374	427	481	534	601	668	734	801	868	935	1,001	1,068			
			I/1'															
			1200	1400	1600	1800	2000	2250	2500	2750	3000	3250	3500	3750	4000			
125 mm	100 mm	1450	H mt.	129	127	125	123	121	118	116	113	110	104	93				
			H feet	430	423	417	410	403	393	387	377	367	347	310				
			Hp ass.	60	66.0	71	76	81	87	90	93	95	108	109				
		1750	H mt.	187	186	182	181	180	176	172	169	167	162	158	153	148		
			H feet	623	620	607	603	600	587	573	563	557	540	527	510	493		
			Hp ass.	98	102	107	115	123	132	142	150	156	161	165	181	188		

Tipo Type CS-P1003BS					Tipo Type CS-P1003BBRX					Tipo Type CS-P1003BTBX				
-----------------------------	--	--	--	--	-------------------------------	--	--	--	--	-------------------------------	--	--	--	--

Girante Prim. - Prim. Impeller: ø 400 mm
 Apertura - Opening: 14 mm

Girante Sec. - Sec. Impeller: ø 330 mm
 Apertura - Opening: 15 mm

Bocche pompa Ports pump	Giri pompa/1'	m3/h																
			72	84	96	108	120	135	150	165	180	195	210	225	240			
DNa	DNm	RPM	G/min															
			320	374	427	481	534	601	668	734	801	868	935	1,001	1,068			
			I/1'															
			1200	1400	1600	1800	2000	2250	2500	2750	3000	3250	3500	3750	4000			
125 mm	100 mm	1450	H mt.	124	122	120	118	116	113	111	108	106	99	89				
			H feet	413	407	400	393	387	377	370	360	353	330	297				
			Hp ass.	57.5	63	68	73	77	83	86	89	91	103	104				
		1750	H mt.	179	178	174	173	172	168	165	162	160	155	151	147	142		
			H feet	597	593	580	577	573	560	550	540	533	517	503	490	473		
			Hp ass.	94	98	102	110	117	126	136	144	149	154	157	174	180		

Tipo Type CS-P1003CS					Tipo Type CS-P1003CBRX					Tipo Type CS-P1003CTBX				
-----------------------------	--	--	--	--	-------------------------------	--	--	--	--	-------------------------------	--	--	--	--

Girante Prim. - Prim. Impeller: ø 380 mm
 Apertura - Opening: 14 mm

Girante Sec. - Sec. Impeller: ø 330 mm
 Apertura - Opening: 15 mm

Bocche pompa Ports pump	Giri pompa/1'	m3/h																
			72	84	96	108	120	135	150	165	180	195	210	225	240			
DNa	DNm	RPM	G/min															
			320	374	427	481	534	601	668	734	801	868	935	1,001	1,068			
			I/1'															
			1200	1400	1600	1800	2000	2250	2500	2750	3000	3250	3500	3750	4000			
125 mm	100 mm	1450	H mt.	118.5	118	115	113	110	107	103	99	95	90	79				
			H feet	395	393	383	377	367	357	343	330	317	300	263				
			Hp ass.	55	61	65	69	73	77	80	85	88	92	95				
		1750	H mt.	175	173	168	166	164	160	155	152	148	144	138	136	128		
			H feet	583	577	560	553	547	533	517	507	493	480	460	453	427		
			Hp ass.	90	95	98	104	112	119	126	132	138	143	148	154	160		



Pompe autoadescanti per acque sporche ad asse nudo
Self - priming bare shaft pumps for dirty waters
 Pompes auto-amorçante arbre nu pour eau chargées
 Bombas autocebantes eje libre para agua sucia

Serie **CS-P**
 Series

Tipo Type CS-P1003DS				Tipo Type CS-P1003DBRX								Tipo Type CS-P1003DTBX							
-----------------------------	--	--	--	-------------------------------	--	--	--	--	--	--	--	-------------------------------	--	--	--	--	--	--	--

Girante Prim. - Prim. Impeller: ø 360 mm
 Apertura - Opening: 14 mm

Girante Sec. - Sec. Impeller: ø 330 mm
 Apertura - Opening: 15 mm

Bocche pompa Ports pump	Giri pompa/1'	m3/h	72	84	96	108	120	135	150	165	180	195	210	225	240	DNa	DNm	RPM	1450		1750			
																			H mt.	H feet	Hp ass.	H mt.	H feet	Hp ass.
		G/min	320	374	427	481	534	601	668	734	801	868	935	1,001	1,068									
		l/1'	1200	1400	1600	1800	2000	2250	2500	2750	3000	3250	3500	3750	4000									
125 mm	100 mm	1450	H mt.	113	112	110	108	106	104	100	95	91	88	76										
			H feet	377	373	367	360	353	347	333	317	303	293	253										
			Hp ass.	52	58	62	65	71	76	77	78	79	86	89										
		1750	H mt.	164	163	160	159	158	155	151	149	146	142	136	134	125								
			H feet	547	543	533	530	527	517	503	497	487	473	453	447	417								
			Hp ass.	86	89	94	101	107	116	124	130	136	141	142	151	155								

Tipo Type CS-P1004BS				Tipo Type CS-P1004BBRX								Tipo Type CS-P1004BTBX							
-----------------------------	--	--	--	-------------------------------	--	--	--	--	--	--	--	-------------------------------	--	--	--	--	--	--	--

Girante Prim. - Prim. Impeller: ø 400 mm
 Apertura - Opening: 14 mm

Girante Sec. - Sec. Impeller: ø 330 mm
 Apertura - Opening: 15 mm

Bocche pompa Ports pump	Giri pompa/1'	m3/h	72	84	96	108	120	135	150	165	180	195	210	225	240	DNa	DNm	RPM	1450		1750			
																			H mt.	H feet	Hp ass.	H mt.	H feet	Hp ass.
		G/min	320	374	427	481	534	601	668	734	801	868	935	1,001	1,068									
		l/1'	1200	1400	1600	1800	2000	2250	2500	2750	3000	3250	3500	3750	4000									
125 mm	100 mm	1450	H mt.	155	152	149	146	142	139	136	133	128	118	115										
			H feet	517	507	497	487	473	463	453	443	427	393	383										
			Hp ass.	72	78.5	86	92	98	102	106	110	113	128	130										
		1750	H mt.	223	219	216	212	207	202	197	193	186	181	174	167									
			H feet	743	730	720	707	690	673	657	643	620	603	580	557									
			Hp ass.	122	126	136	146	157	168	175	181	187	192	205	217									

Tipo Type CS-P1503IRS																							
------------------------------	--	--	--	--	--	--	--	--	--	--	--	--	--	--	--	--	--	--	--	--	--	--	--

Bocche pompa Ports pump	Giri pompa/1'	m3/h	90	120	150	180	210	225	240	255	270	285	DNa	DNm	RPM	1450		1600		
																H mt.	H feet	Hp ass.	H mt.	H feet
		G/min	401	534	668	801	935	1,001	1,068	1,135	1,202	1,268								
		l/1'	1500	2000	2500	3000	3500	3750	4000	4250	4500	4750								
150 mm	125 mm	1450	H mt.	112	111	108	105	99	95	90.5	84	75.5								
			H feet	373	370	360	350	330	317	302	280	252								
			Hp ass.	65.5	75.5	86	96	106	111	114	118	120								
		1600	H mt.	136	134	133	130	127	125	122	119	115	110							
			H feet	453	447	443	433	423	417	407	397	383	367							
			Hp ass.	79	91	103	115	128	134	139	147	152	158							
1600	H mt.	166	164	161	157															
	H feet	553	547	537	523															
	Hp ass.	120	131	151	166															

Tipo Type CS-P1503ERS																							
------------------------------	--	--	--	--	--	--	--	--	--	--	--	--	--	--	--	--	--	--	--	--	--	--	--

Bocche pompa Ports pump	Giri pompa/1'	m3/h	90	120	150	180	210	225	240	255	270	285	DNa	DNm	RPM	1450		1600	
																H mt.	H feet	Hp ass.	H mt.
		G/min	401	534	668	801	935	1,001	1,068	1,135	1,202	1,268							
		l/1'	1500	2000	2500	3000	3500	3750	4000	4250	4500	4750							
150 mm	125 mm	1450	H mt.	136	134	133	130	127	125	122	119	115	110						
			H feet	453	447	443	433	423	417	407	397	383	367						
			Hp ass.	79	91	103	115	128	134	139	147	152	158						
		1600	H mt.	166	164	161	157												
			H feet	553	547	537	523												
			Hp ass.	120	131	151	166												

Tipo Type CS-P1503GRS																							
------------------------------	--	--	--	--	--	--	--	--	--	--	--	--	--	--	--	--	--	--	--	--	--	--	--

Bocche pompa Ports pump	Giri pompa/1'	m3/h	90	120	150	180	210	225	240	255	270	285	DNa	DNm	RPM	1450		1600	
																H mt.	H feet	Hp ass.	H mt.
		G/min	401	534	668	801	935	1,001	1,068	1,135	1,202	1,268							
		l/1'	1500	2000	2500	3000	3500	3750	4000	4250	4500	4750							
150 mm	125 mm	1450	H mt.	124	122	120	117	113	110	106	101	95	86						
			H feet	413	407	400	390	377	367	353	337	317	287						
			Hp ass.	73	84	95	107	118	123	128	134	137	138						
		1600	H mt.	149	147	144	140	138	133										
			H feet	497	490	480	467	460	443										
			Hp ass.	108	121	137	149	155	161										



Pompe autoadescanti per acque sporche ad asse nudo
Self - priming bare shaft pumps for dirty waters
 Pompes auto-amorçante arbre nu pour eaux chargées
 Bombas autocebantes eje libre para agua sucia

Serie **CS-P**
 Series

Tipo Type **CS-P1502MRS**

Bocche pompa Ports pump		Giri pompa/1' RPM	m3/h	90	120	150	180	210	225	240	255	270	285	300					
DNa	DNm		G/min	401	534	668	801	935	1,001	1,068	1,135	1,202	1,268	1,335					
			l/1'	1500	2000	2500	3000	3500	3750	4000	4250	4500	4750	5000					
150 mm	125 mm	1450	H mt.	67	66	64	62	57	54	51	46	40							
			H feet	223	220	213	207	190	180	170	153	133							
			Hp ass.	37	43	49	54	50	61	63	65	66							
		1600	H mt.		79	77	75	71	68	65	61	57	53						
			H feet		263	257	250	237	227	217	203	190	177						
			Hp ass.		54	61	69	76	78	81	83	85	86						
		1800	H mt.		102	100	98	95	93	90	86	82	76	68					
			H feet		340	333	327	317	310	300	287	273	253	227					
			Hp ass.		73	82	91	100	105	109	112	115	118	120					

Tipo Type **CS-P1502GRS**

Bocche pompa Ports pump		Giri pompa/1' RPM	m3/h	120	150	180	210	225	240	255	270	285	300					
DNa	DNm		G/min	534	668	801	935	1,001	1,068	1,135	1,202	1,268	1,335					
			l/1'	2000	2500	3000	3500	3750	4000	4250	4500	4750	5000					
150 mm	125 mm	1450	H mt.	86	85	83	80	78	75	71	66	156						
			H feet	287	283	277	267	260	250	237	220	520						
			Hp ass.	60	68	76	84	87	90	93	95	96						
		1600	H mt.	105	104	102	99	97	95	92	89	84						
			H feet	350	347	340	330	323	317	307	297	280						
			Hp ass.	78	87	97	106	110	114	118	121	123						
		1800	H mt.	133	132	130	128	126	124	122	119	116	110					
			H feet	443	440	433	427	420	413	407	397	387	367					
			Hp ass.	104	115	128	140	146	153	159	164	169	174					



Pompe autoadesanti per acque sporche ad asse nudo
Self - priming bare shaft pumps for dirty waters
 Pompes auto-amorçante arbre nu pour eau chargées
 Bombas autocebantes eje libre para agua sucia

CURVE - CURVES - COURBES - CURVAS

CS-S2A17S

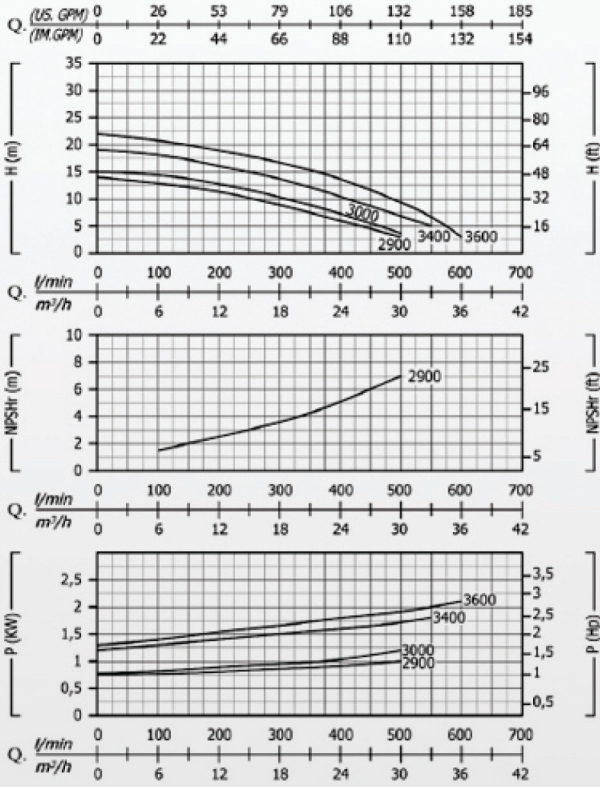

CS-S2A22S

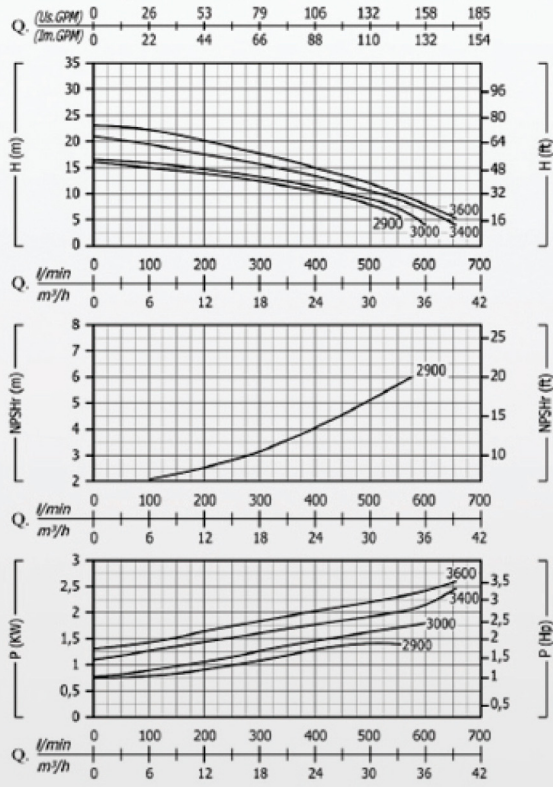

CS-S3A12S

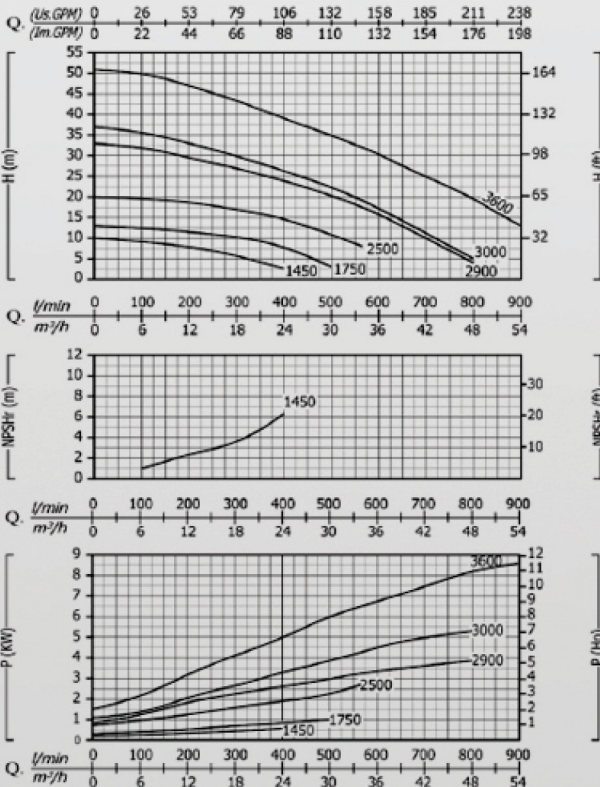

CS-S3A16S

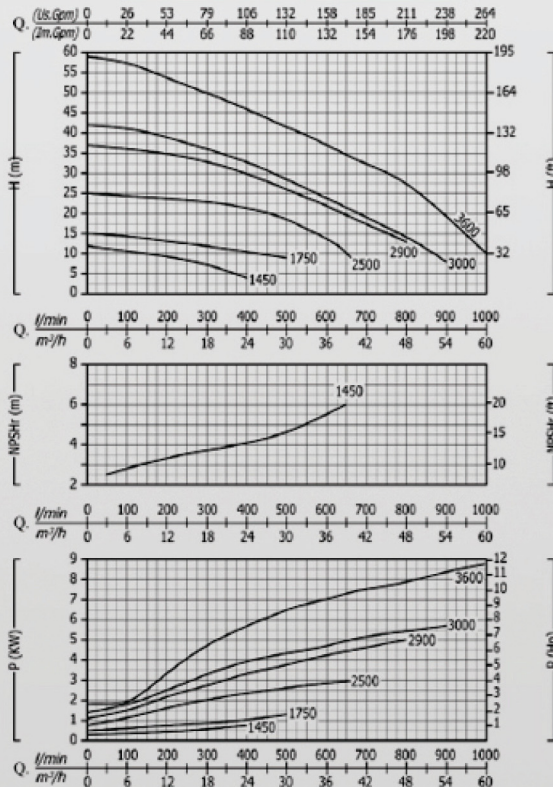



Pompe autoadescanti per acque sporche ad asse nudo
Self-priming bare shaft pumps for dirty waters
 Pompes auto-amorçante arbre nu pour eau chargées
 Bombas autocebantes eje libre para agua sucia

CURVE - CURVES - COURBES - CURVAS

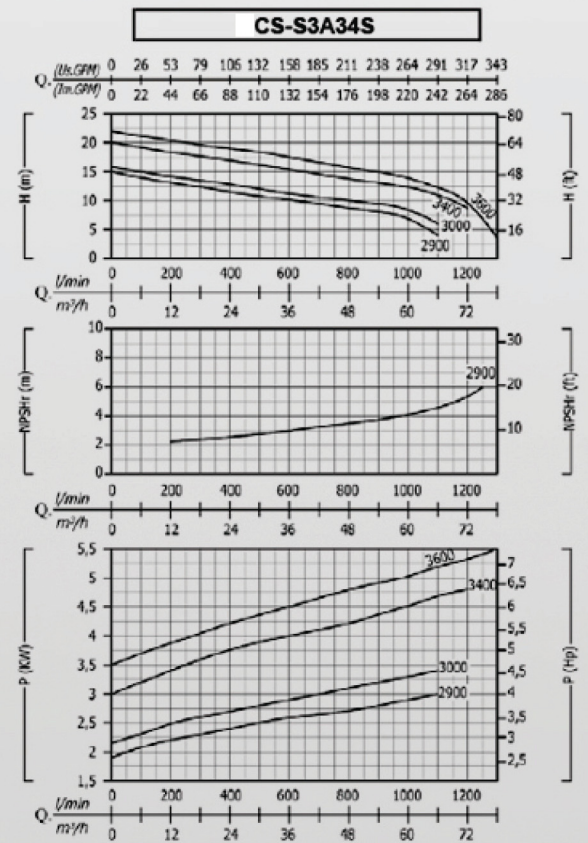
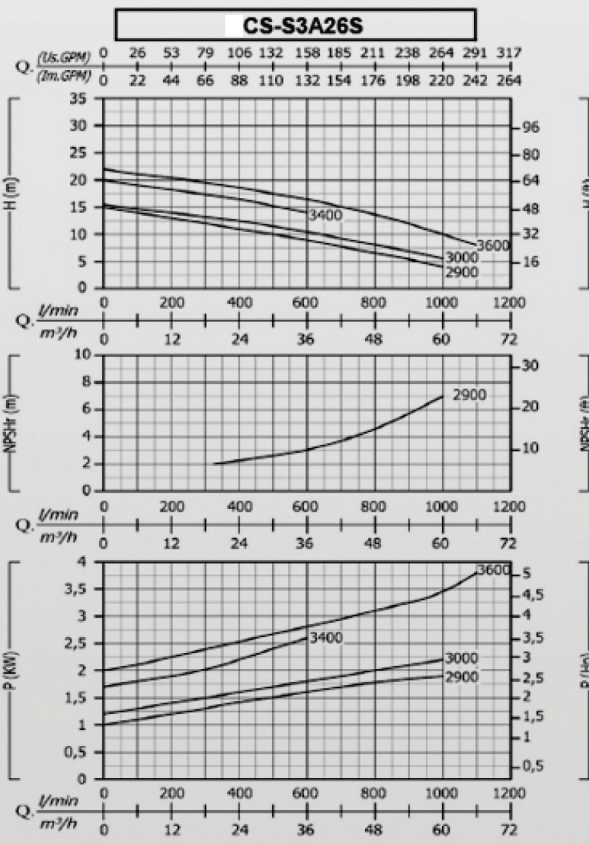
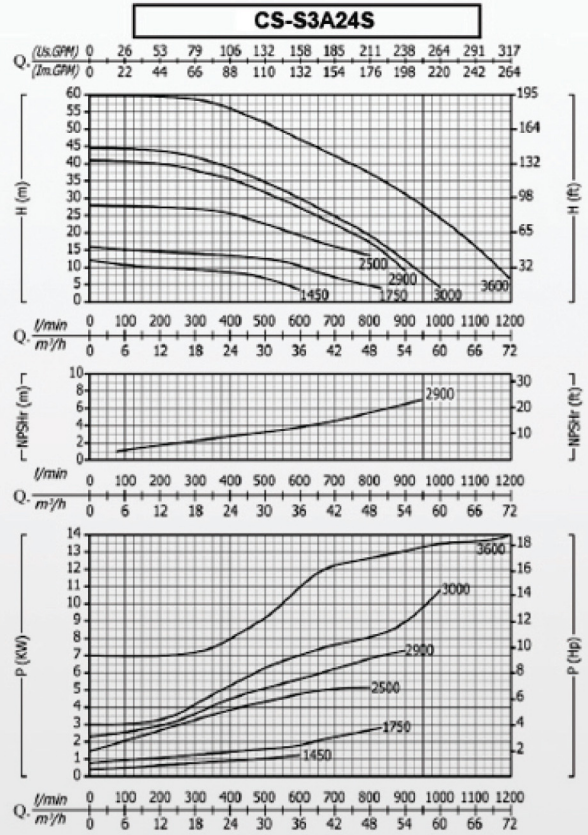
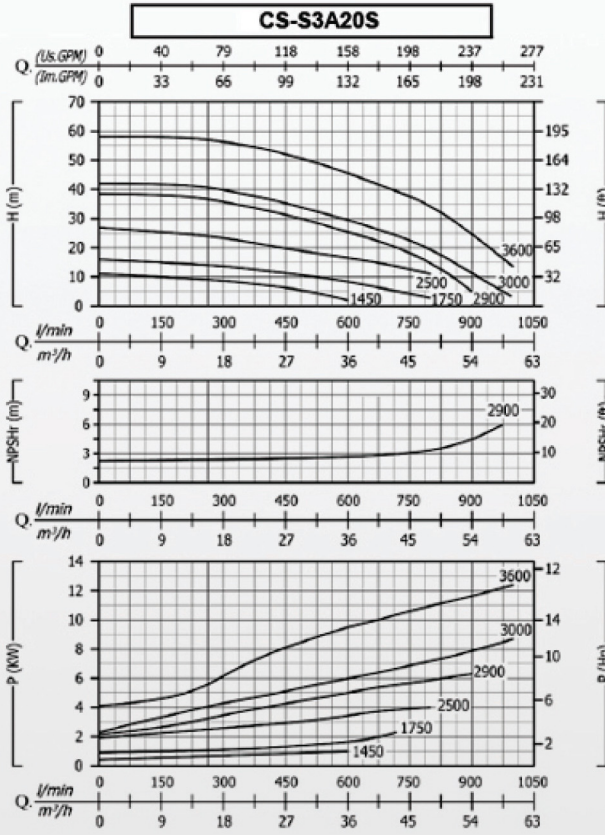



Pompe autoadescanti per acque sporche ad asse nudo
Self-priming bare shaft pumps for dirty waters
 Pompes auto-amorçante arbre nu pour eaur chargées
 Bombas autocebantes eje libre para agua sucia

CURVE - CURVES - COURBES - CURVAS

CS-S3A2914S

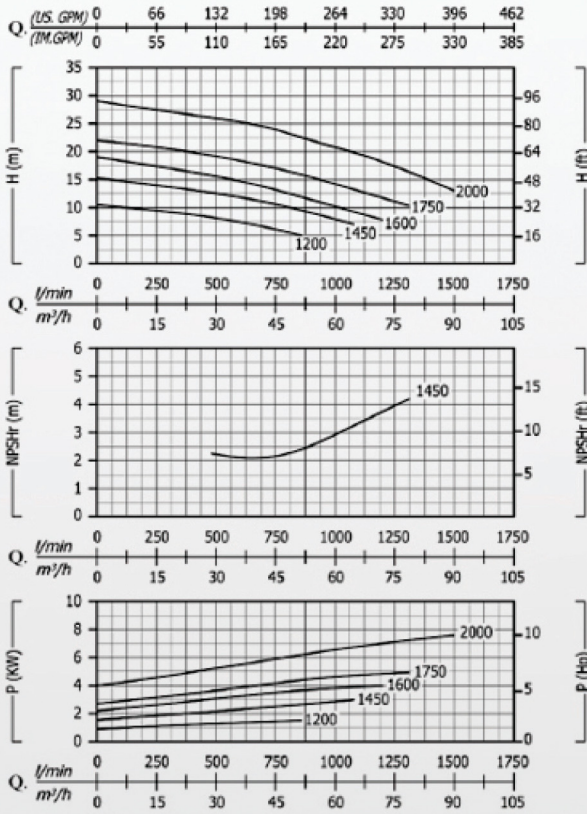

CS-S4A45S

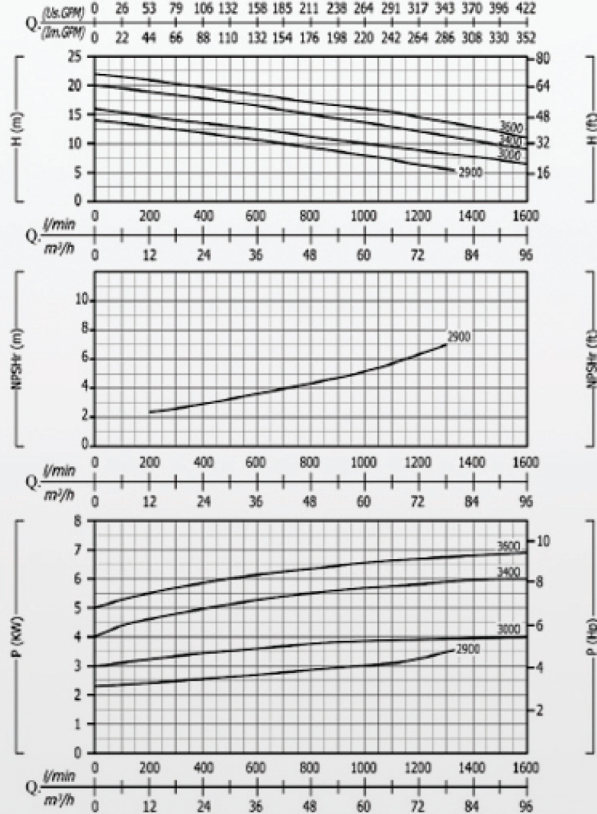

CS-S4A1655S

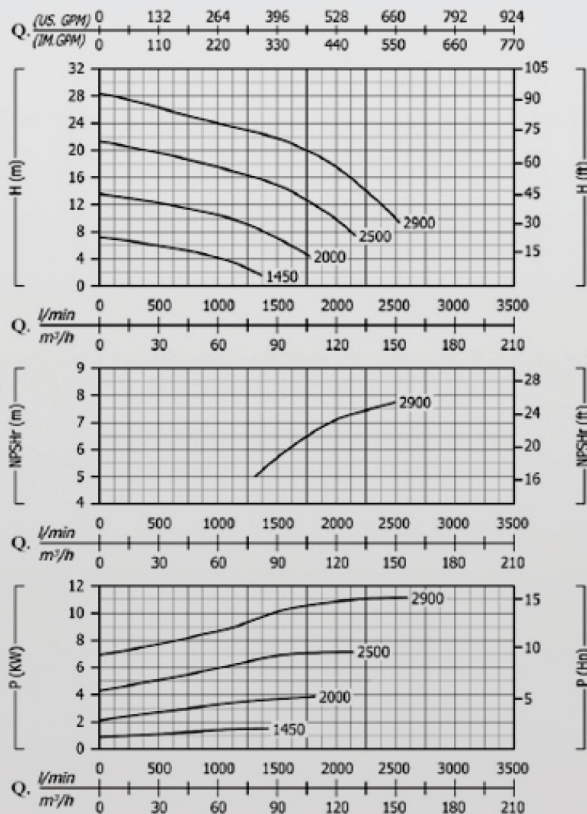

CS-S4A1722S

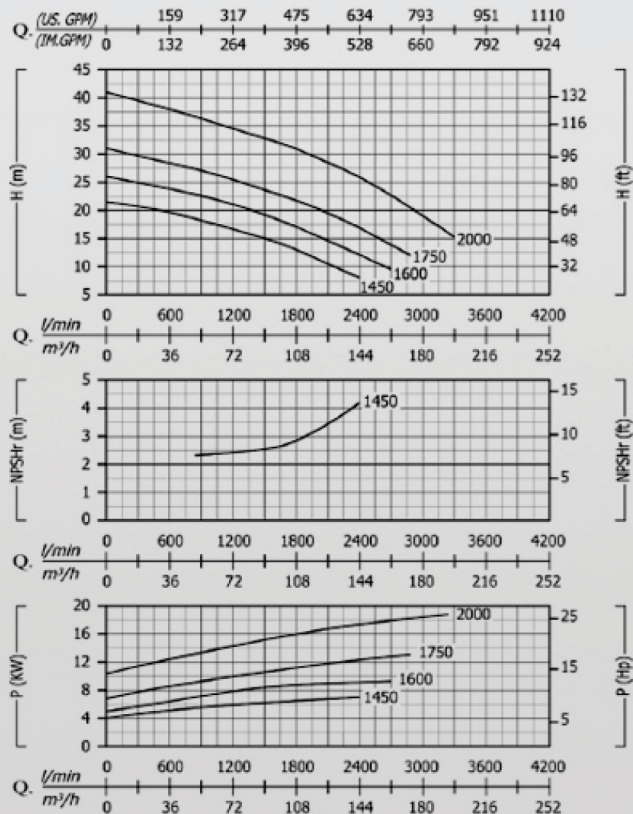



Pompe autoadescanti per acque sporche ad asse nudo
Self-priming bare shaft pumps for dirty waters
 Pompes auto-amorçante arbre nu pour eaur chargées
Bombas autocebantes eje libre para agua sucia

CURVE - CURVES - CURVES - CURVAS

CS-S4A1831S

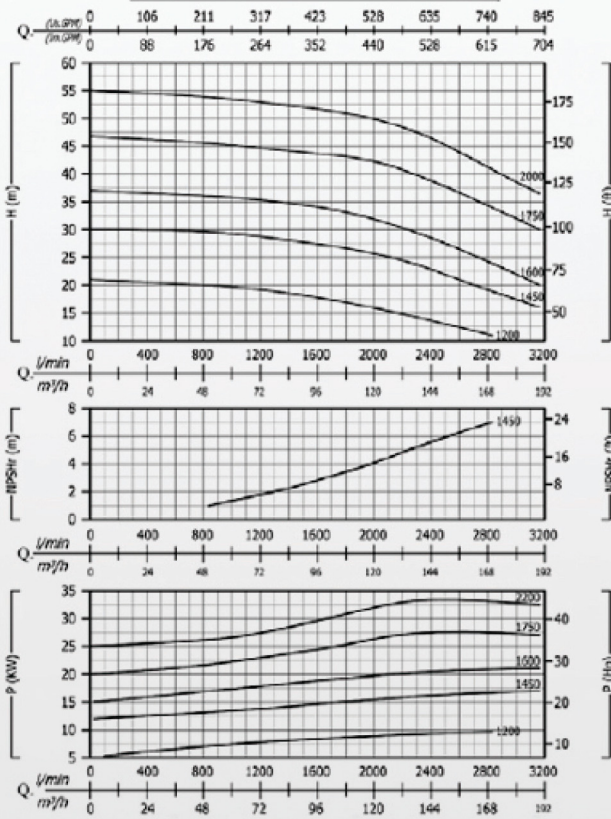

CS-S6A2337S

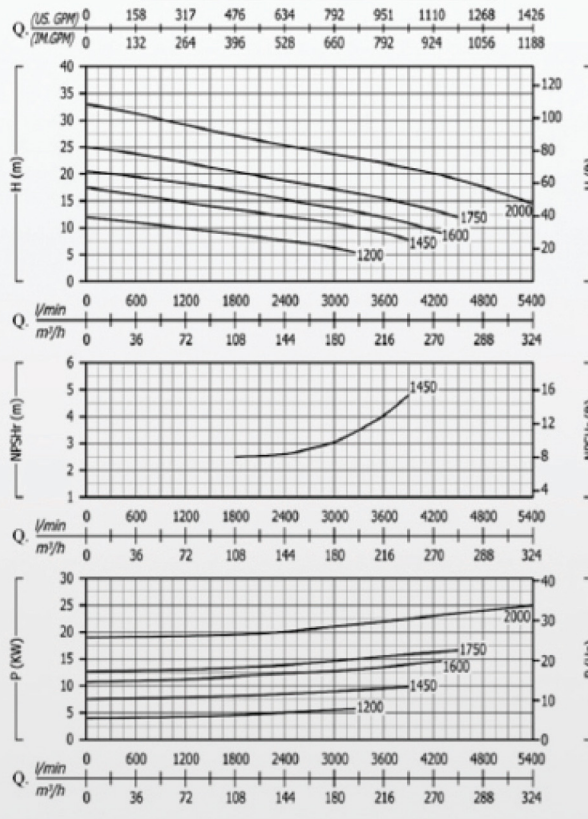

CS-S6A2206S

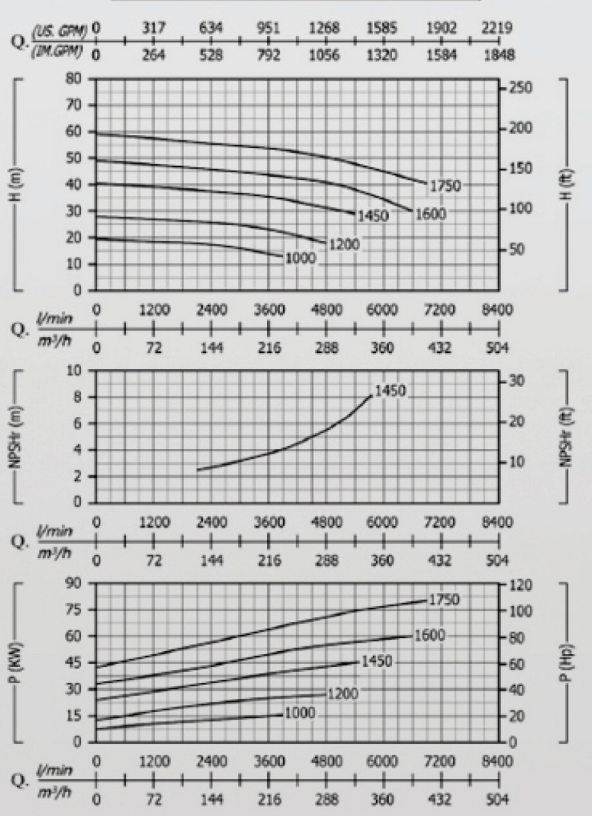

CS-S8A2414S

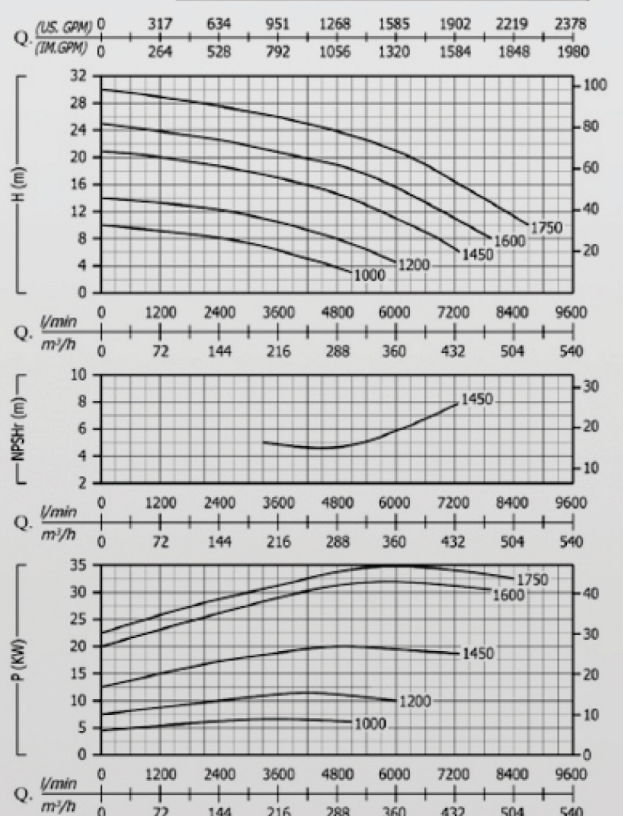



Pompe autoadescanti per acque sporche ad asse nudo
Self-priming bare shaft pumps for dirty waters
 Pompes auto-amorçante arbre nu pour eau chargées
 Bombas autocebantes eje libre para agua sucia

CS-S10A2507S

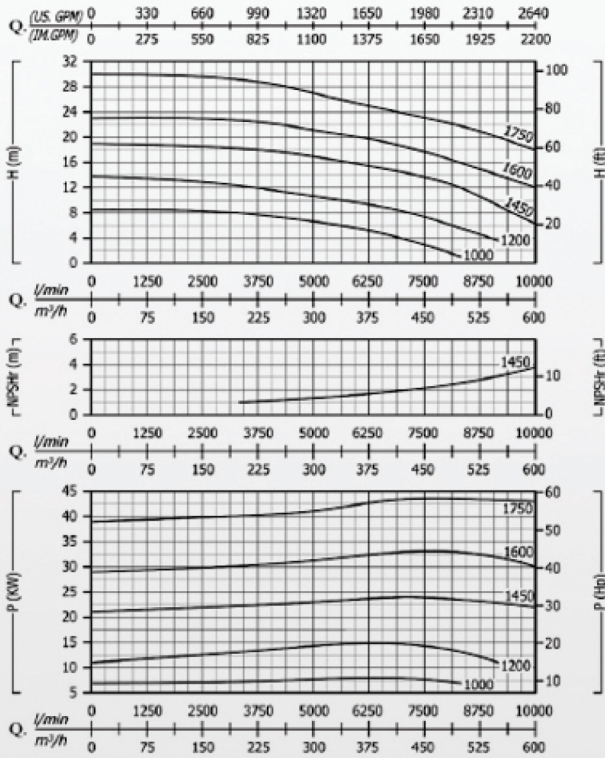

CURVE - CURVES - COURBES - CURVAS

Tipo - Type	Bocche pompa Ports pumps		Passaggio corpi solidi Solids handling	Diametro girante Impeller diameter	Numero pale Number of blades	Peso Weight (kg)
	Dna	DNm				
JCS-S2A17S	2"	2"	Ø 17 mm	Ø 108 mm	3	14
JCS-S2A22S	2"	2"	Ø 22 mm	Ø 108 mm	7	14
JCS-S3A12S	3"	3"	Ø 12 mm	Ø 180 mm	5	47
JCS-S3A16S	3"	3"	Ø 16mm	Ø 180 mm	5	47
JCS-S3A20S	3"	3"	Ø 20 mm	Ø 180 mm	5	47
JCS-S3A24S	3"	3"	Ø 24 mm	Ø 180 mm	5	47
JCS-S3A26S	3"	3"	Ø 26 mm	Ø 108 mm	3	18
JCS-S3A34S	3"	3"	Ø 34 mm	Ø 108 mm	3	18
JCS-S3A2914	3"	3"	Ø 40 mm	Ø 215 mm	3	74
JCS-S4A45S	4"	4"	Ø 45 mm	Ø 129 mm	3	48
JCS-S4A1655S	4"	4"	Ø 50 mm	Ø 160 mm	3	75
JCS-S4A1722	4"	4"	Ø 48 mm	Ø 249 mm	2	130
JCS-S4A1831S	4"	4"	Ø 38 mm	Ø 315 mm	4	172
JCS-S6A2206S	150 (6")	150 (6")	Ø 50 mm	Ø 375 mm	4	405
JCS-S6A2337S	150 (6")	150 (6")	Ø 76 mm	Ø 249,5 mm	2	235
JCS-S8A2414S	200 (8")	200 (8")	Ø 60 mm	Ø 297 mm	4	296
JCS-S10A2507	250 (10")	250 (10")	Ø 76 mm	Ø 305 mm	2	550

SCHEDA DATI - DATA SHEET - DONNES - DATOS



Pompe autoadescanti per acque sporche ad asse nudo
Self-priming bare shaft pumps for dirty waters
 Pompes auto-amorçante arbre nu pour eaux chargées
 Bombas autocebantes eje libre para agua sucia

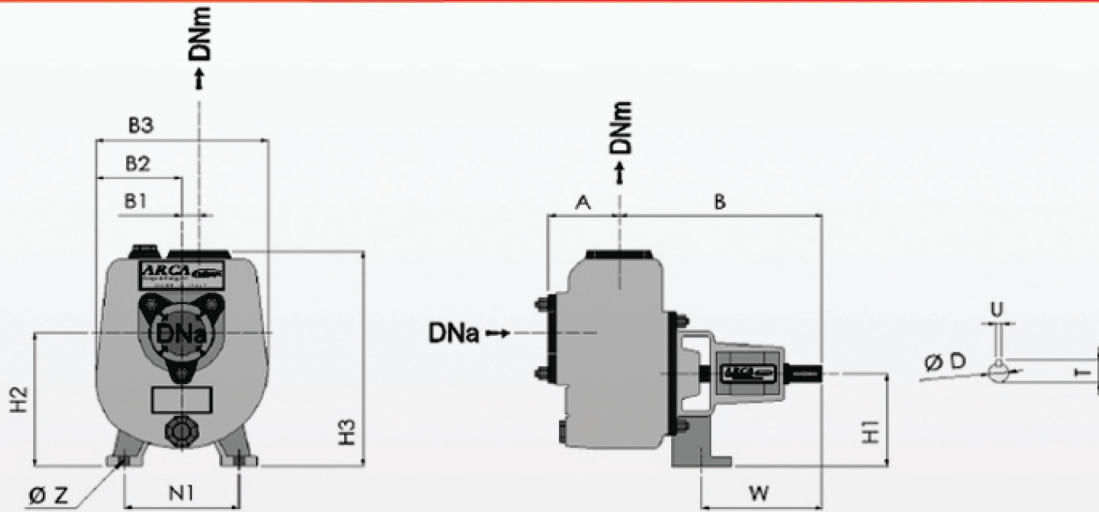

DIMENSIONI - DIMENSIONS

Tipo - Type	TABELLA - TABLE - TABLEAU - TABLA														
	B1	B2	B3	H1	H2	H3	N1	F	A	L	W	T	U	D	Z
JCS-S2A17S	32	80	205	115	165	268	140	237	85	42	138	22	6	19	2
JCS-S2A22S	32	80	205	115	165	268	140	237	85	42	138	22	6	19	2
JCS-S3A26S	33	116	230	115	163	299	140	256	120	42	138	22	6	19	2
JCS-S3A34S	33	116	230	115	163	299	140	256	120	42	138	22	6	19	2

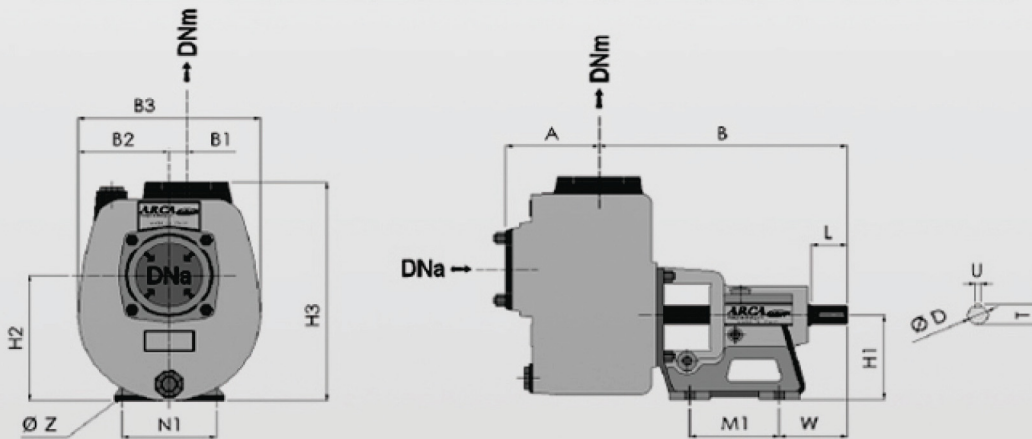

Tipo - Type	TABELLA - TABLE - TABLEAU - TABLA															
	B1	B2	B3	H1	H2	H3	N1	F	A	L	W	M1	T	U	D	Z
JCS-S3A12S	30	117	269	132	237	382	120	400	132	45	105	138	27	6	24	16
JCS-S3A16S	30	117	269	132	237	382	120	400	132	45	105	138	27	6	24	16
JCS-S3A20S	30	117	269	132	237	382	120	400	132	45	105	138	27	6	24	16
JCS-S3A24S	30	117	269	132	237	382	120	400	132	45	105	138	27	6	24	16
JCS-S4A45S	28	145	290	132	204	360	120	433	109	45	105	138	23	6	20	16
JCS-S4A1655S	37	150	300	160	340	460	150	500	180	65	115	155	31	8	28	16



Pompe autoadescanti per acque sporche ad asse nudo
Self-priming bare shaft pumps for dirty waters
 Pompes auto-amorçante arbre nu pour eaux chargées
 Bombas autocebantes eje libre para agua sucia

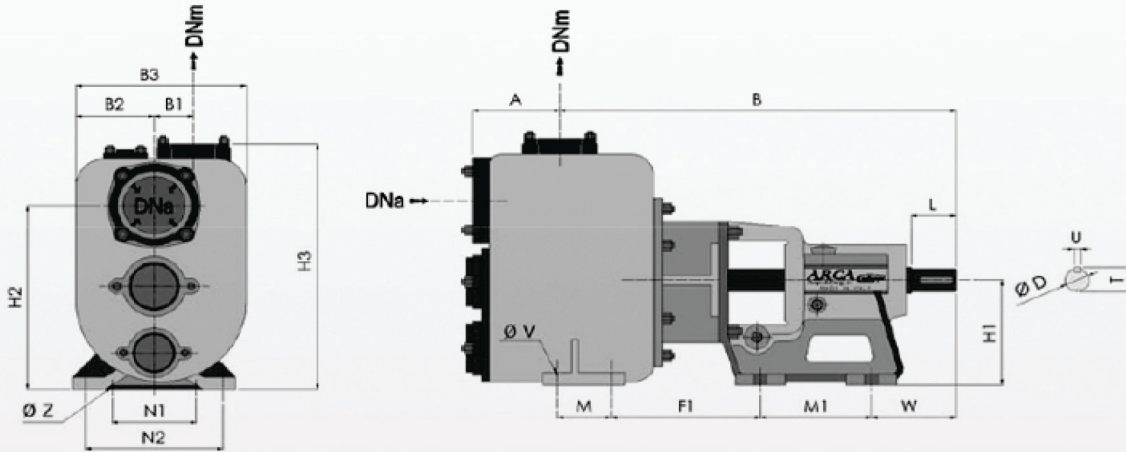

DIMENSIONI - DIMENSIONS

Tipo -Type	TABELLA - TABLE - TABLEAU - TABLA																			
	B1	B2	B3	H1	H2	H3	N1	N2	F	A	L	W	M1	F1	M	T	U	D	V	Z
JCS-S3A2914	70	139	303	160	310	410	150	245	458	155	60	110	125	150	100	31	8	28	14	14

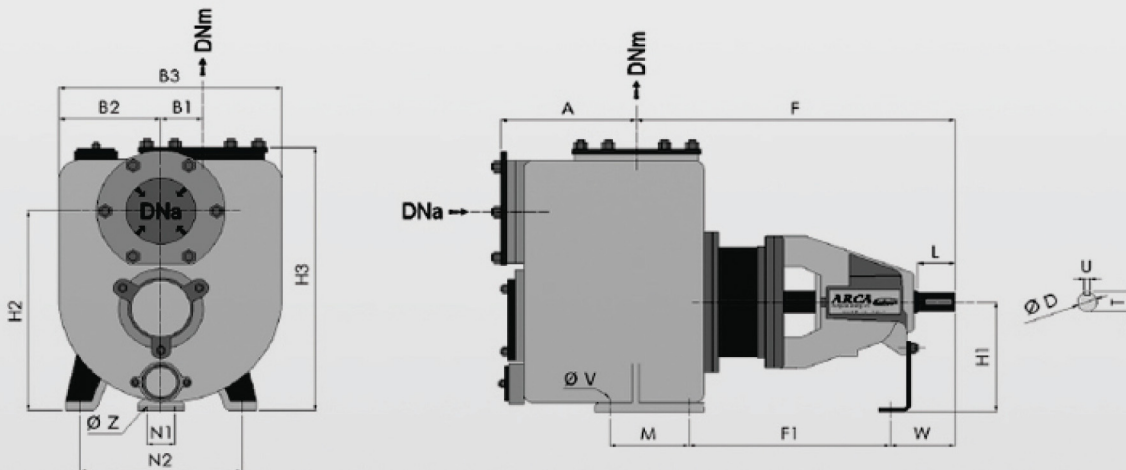



Tipo -Type	TABELLA - TABLE - TABLEAU - TABLA																		
	B1	B2	B3	H1	H2	H3	N1	N2	F	A	L	W	F1	M	T	U	D	V	Z
JCS-S4A1722	160	180	360	195	350	487	60	295	591	278	80	136	464	95	45	12	42	14	12
JCS-S4A1831	220	230	530	280	450	577	150	400	622	265	110	168	424	150	45	12	42	14	18
JCS-S6A2206	280	280	698	350	637	790	60	450	691	380	110	157	462	200	51	12	48	18	12
JCS-S6A2337	90	220	480	250	455	600	60	350	685	280	80	139	433	170	45	12	42	18	12
JCS-S8A2414	80	283	585	315	527	704	60	450	785	307	110	169	508	200	45	12	42	18	12
JCS-S10A2507	255	298	758	350	687	942	150	450	719	478	110	181	488	250	59	16	55	18	17



SPICO Co. Solo Agent of Cadoppi in IRAN

.....
 Central office ; spico building , NO : 403 , South Saadi Ave, Tehran - IRAN

 +98 (21) 33943519 - 21

 +98 (21) 33116222

 info@spicoir.com

 www.spico.ir

